

Features

- Reduced RFI and EMI
- Reduced Snubbing
- Extensive Characterization of Recovery Parameters

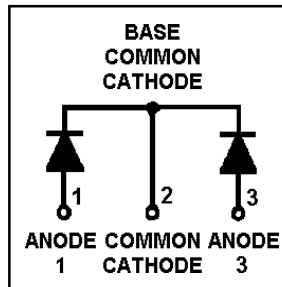

$V_R = 600V$
$V_F(\text{typ.})^{\textcircled{3}} = 1.2V$
$I_{F(AV)} = 70A$
$Q_{rr}(\text{typ.}) = 210nC$
$I_{RRM}(\text{typ.}) = 6A$
$t_{rr}(\text{typ.}) = 30ns$
$di_{(rec)M}/dt(\text{typ.})^{\textcircled{3}} = 180A/\mu s$

Description

HEXFRED™ diodes are optimized to reduce losses and EMI/RFI in high frequency power conditioning systems. An extensive characterization of the recovery behavior for different values of current, temperature and di/dt simplifies the calculations of losses in the operating conditions. The softness of the recovery eliminates the need for a snubber in most applications. These devices are ideally suited for power converters, motors drives and other applications where switching losses are significant portion of the total losses.

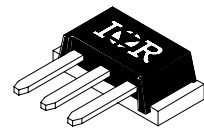

SMD-61-8

Absolute Maximum Ratings (per Leg)

	Parameter	Max.	Units
V_R	Cathode-to-Anode Voltage	600	V
$I_F @ T_C = 25^\circ C$	Continuous Forward Current	56	A
$I_F @ T_C = 100^\circ C$	Continuous Forward Current	27	
I_{FSM}	Single Pulse Forward Current $\textcircled{1}$	200	
E_{AS}	Non-Repetitive Avalanche Energy $\textcircled{2}$	220	μJ
$P_D @ T_C = 25^\circ C$	Maximum Power Dissipation	150	W
$P_D @ T_C = 100^\circ C$	Maximum Power Dissipation	59	
T_J	Operating Junction and	-55 to +150	$^\circ C$
T_{STG}	Storage Temperature Range		
	Soldering Temperature, for 10 sec.	300 (0.063 in. (1.6mm) from case)	

Thermal - Mechanical Characteristics

	Parameter	Min.	Typ.	Max.	Units
R_{thJC}	Junction-to-Case, Single Leg Conducting	—	—	0.85	$^\circ C/W$
	Junction-to-Case, Both Legs Conducting	—	—	0.42	K/W
Wt	Weight	—	4.3 (0.15)	—	g (oz)

Note: $\textcircled{1}$ Limited by junction temperature
 $\textcircled{2}$ L = 100 μH , duty cycle limited by max T_J
 $\textcircled{3}$ 125 $^\circ C$

Electrical Characteristics (per Leg) @ $T_J = 25^\circ\text{C}$ (unless otherwise specified)

Parameter	Min.	Typ.	Max.	Units	Test Conditions	
V_{BR}	Cathode Anode Breakdown Voltage	600	—	—	V	$I_R = 100\mu\text{A}$
V_{FM}	Max Forward Voltage	—	1.3	1.5	V	$I_F = 35\text{A}$ $I_F = 70\text{A}$ See Fig. 1 $I_F = 35\text{A}, T_J = 125^\circ\text{C}$
		—	1.5	1.7		
		—	1.2	1.4		
I_{RM}	Max Reverse Leakage Current	—	2.0	10	μA	$V_R = V_R$ Rated See Fig. 2
		—	0.50	2.0	mA	$T_J = 125^\circ\text{C}, V_R = 480\text{V}$
C_T	Junction Capacitance	—	68	100	pF	$V_R = 200\text{V}$ See Fig. 3
L_S	Series Inductance	—	5.5	—	nH	Lead to lead 5mm from package body

Dynamic Recovery Characteristics (per Leg) @ $T_J = 25^\circ\text{C}$ (unless otherwise specified)

Parameter	Min.	Typ.	Max.	Units	Test Conditions
t_{rr}	Reverse Recovery Time	—	30	—	$I_F = 1.0\text{A}, di/dt = 200\text{A}/\mu\text{s}, V_R = 30\text{V}$
t_{rr1}		—	70	ns	$T_J = 25^\circ\text{C}$ See Fig. 5
t_{rr2}		—	115		$T_J = 125^\circ\text{C}$
I_{RRM1}	Peak Recovery Current	—	6.0	A	$T_J = 25^\circ\text{C}$ See Fig. 6
I_{RRM2}		—	9.0		$T_J = 125^\circ\text{C}$
Q_{rr1}	Reverse Recovery Charge	—	210	nC	$T_J = 25^\circ\text{C}$ See Fig. 7
Q_{rr2}		—	520		$T_J = 125^\circ\text{C}$
$di_{(rec)M}/dt1$	Peak Rate of Fall of Recovery Current During t_b	—	280	$\text{A}/\mu\text{s}$	$T_J = 25^\circ\text{C}$ See Fig. 8
$di_{(rec)M}/dt2$		—	180		$T_J = 125^\circ\text{C}$

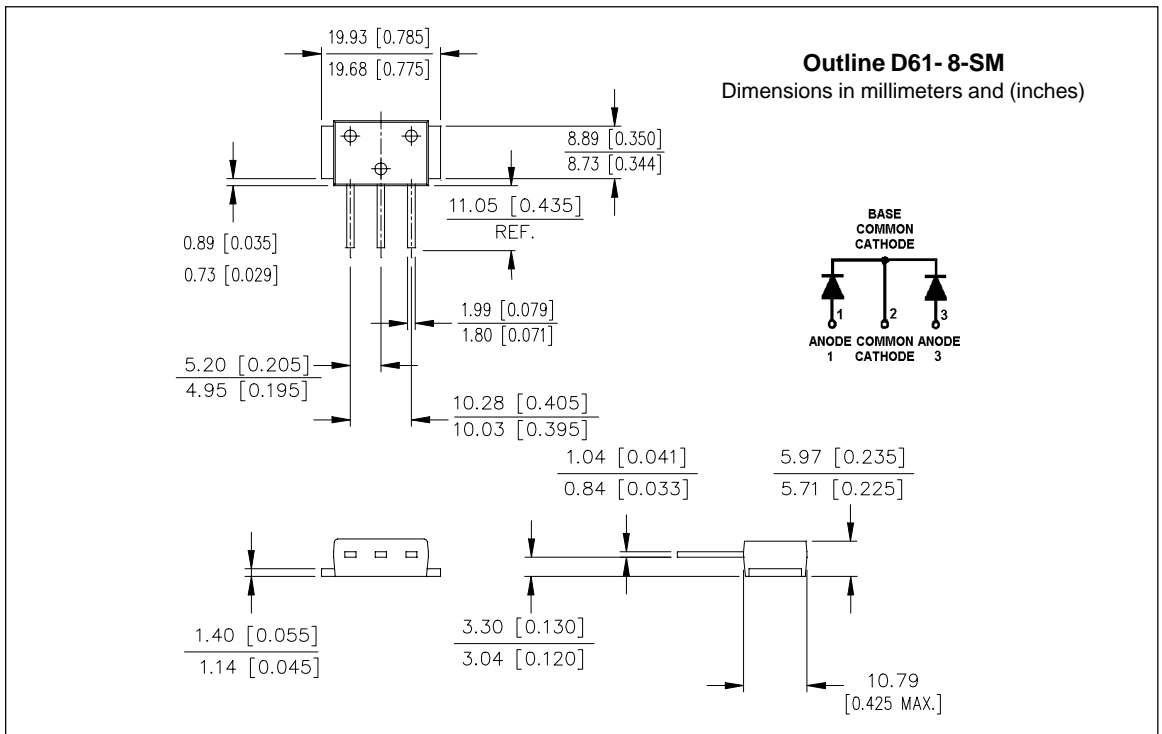

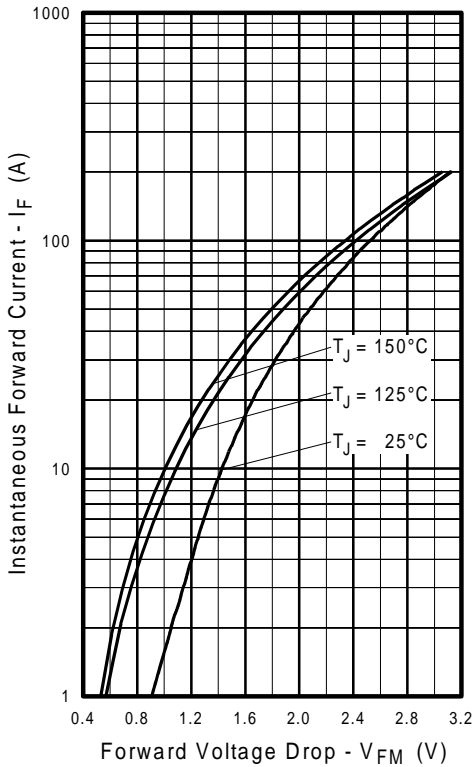

Fig. 1 - Maximum Forward Voltage Drop vs. Instantaneous Forward Current, (per Leg)

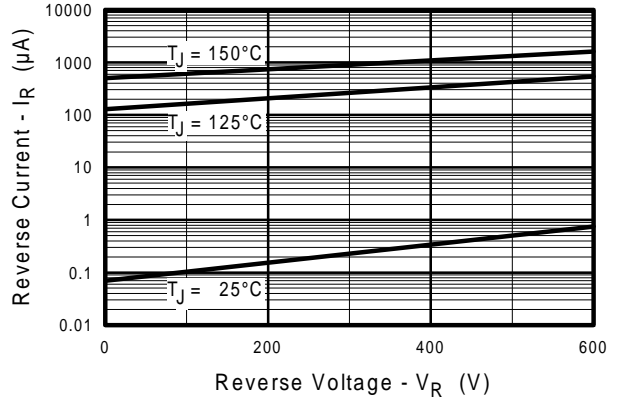

Fig. 2 - Typical Reverse Current vs. Reverse Voltage, (per Leg)

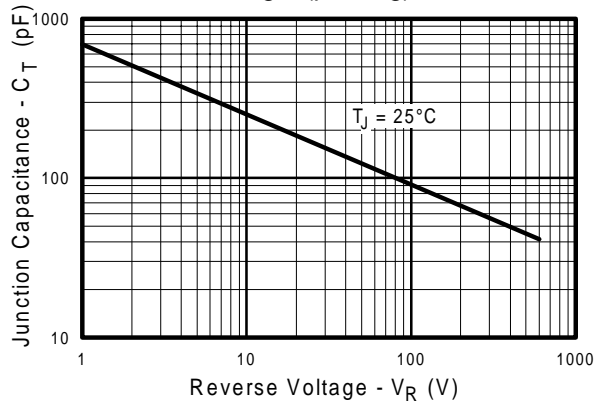

Fig. 3 - Typical Junction Capacitance vs. Reverse Voltage, (per Leg)

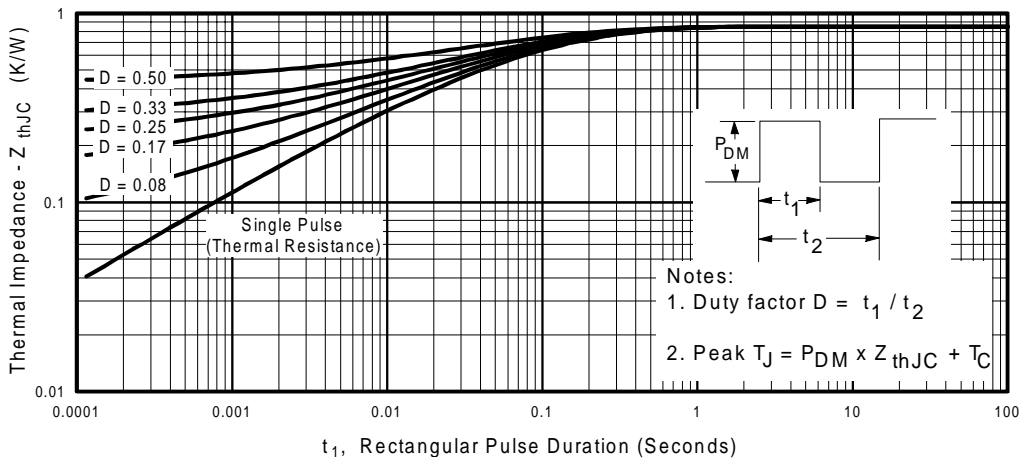

Fig. 4 - Maximum Thermal Impedance Z_{thJC} Characteristics, (per Leg)

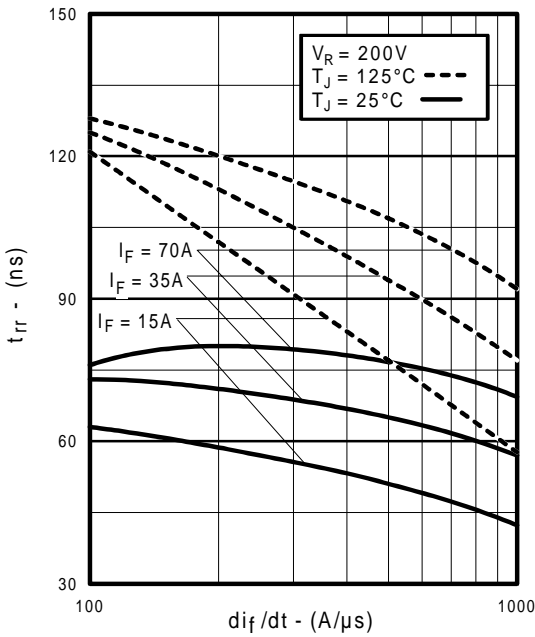

Fig. 5 - Typical Reverse Recovery vs. di/dt , (per Leg)

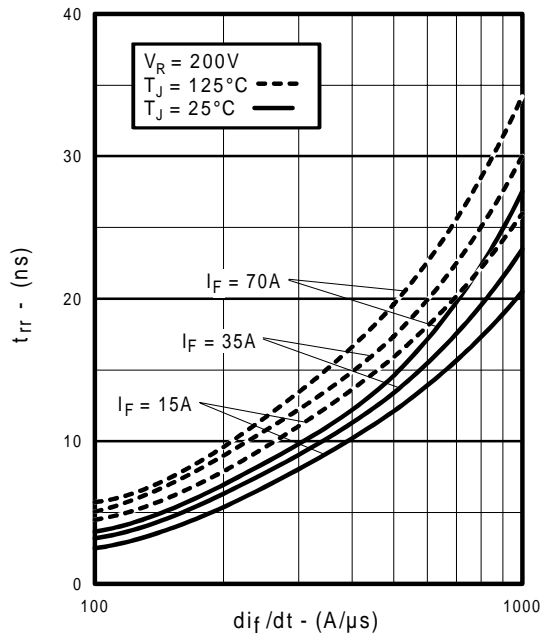

Fig. 6 - Typical Recovery Current vs. di/dt , (per Leg)

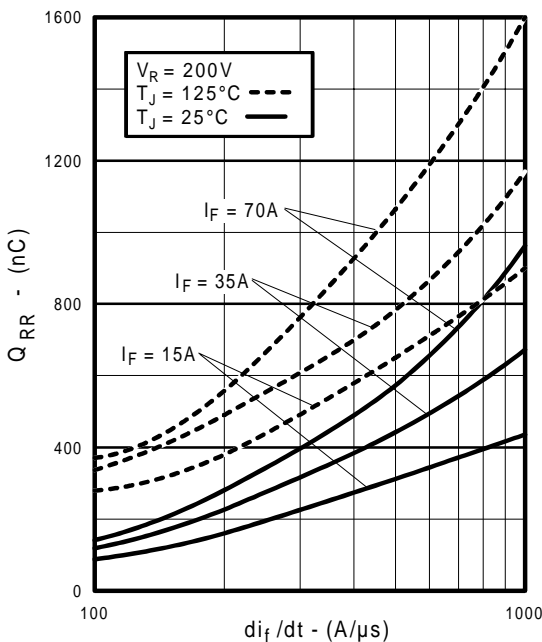

Fig. 7 - Typical Stored Charge vs. di/dt , (per Leg)

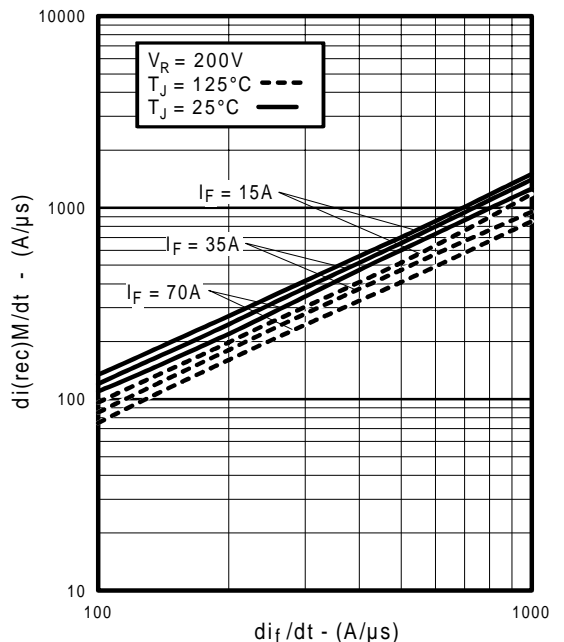

Fig. 8 - Typical $di(\text{rec})M/dt$ vs. di/dt , (per Leg)

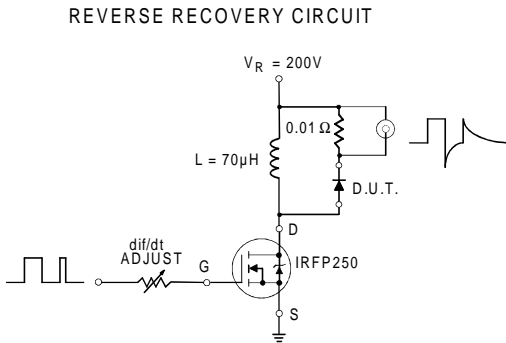

Fig. 9 - Reverse Recovery Parameter Test Circuit

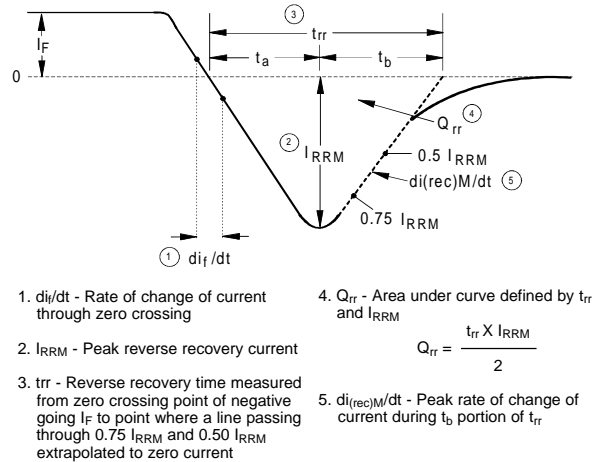

Fig. 10 - Reverse Recovery Waveform and Definitions

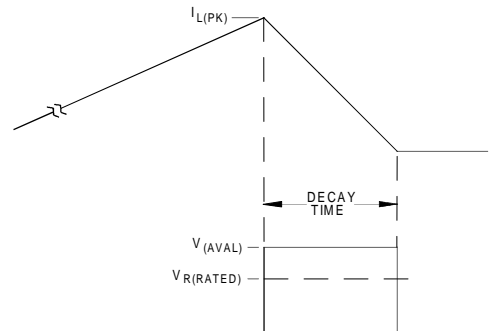
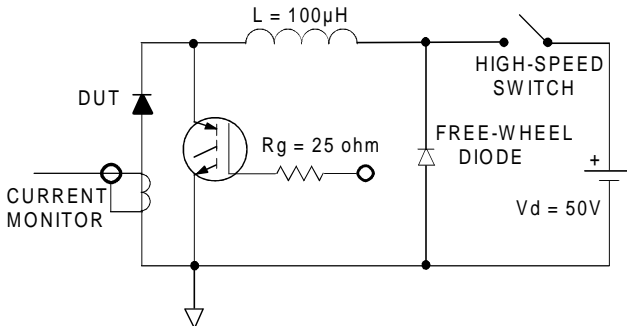

Fig. 11 - Avalanche Test Circuit and Waveforms